



SAFE AT WORK
& back home



Nieuwveen
aan de Oude Rijksweg

Eyecatcher is a manufacturer and international distributor of Heights Safety- and Solar Mounting Systems. Our products represent Dutch Design & Dutch Quality, ensure rapid and easy installation and guarantee your safe home coming after working on heights.

You need roof safety systems to rely on, regardless the activities. The distinct colours and smart appearance of our systems make them highly visible and mark the safety zone. This way Eyecatcher guaranties a safe working area for everyone working on height. Each and every day. Eyecatcher, Focused on your Safety.



SAFE AT WORK

..... *& back home*





**Risk Safety
Assessments
on location**

**Height Safety
Training and
various courses
at Eyecatcher
Training Centre**





**Expertise,
quality products
and practical
solutions for
working at height**

**Annual
Inspection
Safety Systems
and PPE**



CONTENTS

TWISTFIX EN-795:2012 TYPE A	8	DAVIT SYSTEM SYSTEM CONCRETE	
BODYFIX EN-795:2012 TYPE A	10	EN-795:2012 TYPE B	35
TWINFIX EN-795:2012 TYPE A.	12	DAVIT SYSTEM DEAD WEIGHT EN-795:2012 TYPE B&E .	36
RESTRICTFIX EN-795:2012 TYPE A.	14	DAVIT SYSTEM RESTRICTED SPACE	
LOOPFIX EN-795:2012 TYPE A	16	EN-795:2012 TYPE B	37
SEAMFIX EN-795:2012 TYPE A	18	X1250 MOBILE GRABBER EN-795:2012 TYPE B	38
SP-ANCHOR EN-795:2012 TYPE A.	20	RAIL CLAMPS EN-795:2012 TYPE B	40
STEELFIX EN-795:2012 TYPE A	22	HOLLOW CONCRETE CLAMP EN-795:2012 TYPE B . . .	42
SPINFIX EN-795:2012 TYPE A	24	DOORFIX EN-795:2012 TYPE B	44
UNITFIX EN-795:2012 TYPE A	25	CLICKFIX EN-795:2012 TYPE B	46
WALLFIX EN-795:2012 TYPE A	26	MOBILE STEEL & CONCRETE ANCHOR	
SINGLE SAFETY ANCHORS EN-795:2012 TYPE A	28	EN-795:2012 TYPE B	48
DAVIT SYSTEM FREE STANDING		CONTAINER LIFELINE KIT EN-795:2012 TYPE B	50
EN-795:2012 TYPE B&E	32	SAFETY ANCHOR & SAFETY NETS CONNECTOR	
DAVIT SYSTEM FIXED TRIPOD EN-795:2012 TYPE B. . .	33	EN-795:2012 TYPE B	52
DAVIT SYSTEM COLUMN CLAMPED		FIX LIFE LINE SYSTEM EN-795:2012 TYPE C.	54
EN-795:2012 TYPE B	34	TWISTFIX EN-795:2012 TYPE C	56

TWISTFIX EVO EN-795:2012 TYPE C	60	BIGFOOT EN795-2012 TYPE E	92
SOLARFIX LOW EN-795:2012 TYPE C	62	VERTIFIX EN-353-1:2014+A1:2017	94
BODYFIX EN-795:2012 TYPE C	64	ROOFFIX EN-517:2006 TYPE B	96
TWINFIX EN-795:2012 TYPE C	66	LADDERBRACKET	98
SEAMFIX 450 EN-795:2012 TYPE C	68	SAFETY SIGNS	100
SEAMFIX 660 EN-795:2012 TYPE C	70	ROOF ACCESS & CAGE LADDERS	102
STEELFIX EN-795:2012 TYPE C	72	GUARDRAIL & ROOFLIGHTS	103
STEELFIX ASIA EN-795:2012 TYPE C	74	FULL BODY HARNESSSES EN-361/EN-358/EN-813	104
SPINFIX EN-795:2012 TYPE C	76	SAFETY LANYARD EN-354/EN-355/EN-353-2	106
WALLFIX FLAT EN-795:2012 TYPE C	78	SELF RETRACTABLE LIFELINES EN-360	108
WALLFIX SUPPORT EN-795:2012 TYPE C	80	KARABINERS & SCAFFOLD HOOKS EN-362/EN-12275	110
TRAVELFIX EN-795:2012 TYPE C	82	LOOSE PARTS FIX LINE SYSTEM	112
SAFERAIL EN-795:2012 TYPE D	84	INSTALLATION TOOLS	114
SAFERAIL EN-353-1:2014	85	HEIGHT SAFETY SYSTEMS	116
SAFEWALKER	87		
FABA RAILSYSYSTEM EN-353-1:2018	88		
CROSSFIX EN-795:2012 TYPE E	90		

TWISTFIX
EN-795:2012 TYPE A



Twistfix C



- Art. nr.: EC-TF-C
- One M12 anchor required
- Weight: 2.65 lbs. (1,2 kg)

Temporary Lifeline 20 mtr



- Art. nr.: EC-THL-20
- Weight: 10.94 lbs. (4,96 kg)



Twistfix EVO



- Art. nr.: EC-TF-EVO
- One M12 anchor required
- Weight: 1.76 lbs. (0,80kg)

Twistfix EVO PVC



- Art. nr.: EC-TF-EVO-PVC
- One M12 bolt required
- Weight: 2.49 lbs. (1,02 kg)

M12 Concrete Anchor 300 mm



- Art. nr.: EC-MA-12
- Weight: 0.73 lbs. (0,33 kg)

M12 Toggle Bolt 300 mm



- Art. nr.: EC-TF-TP300
- Weight: 1.37 lbs. (0,62 kg)

Positioning Line 5/10/20 mtr



- Art. nrs.: EC-PL-5/-10/-20
- Weight 5mtr: 0.71 lbs. (1,57 kg)
- Weight 10mtr: 0.90 lbs. (1,98 kg)
- Weight 20mtr: 1.28 lbs. (2,78 kg)

Karabiner Anti-Pendulum



- Art. nr.: EC-KB

Full Body Harness Professional



- Art. nr.: EC-FBH-PRO
- Weight: 4.21 lbs. (1,91 kg)

Suitcase Storage PPE



- Art. nr.: EC-K
- Dimensions: 48x36x18 cm
- Weight: 4.21 lbs. (1,91 kg)

BODYFIX
EN-795:2012 TYPE A



Bodyfix Bitumen



- Art. nr.: EC-BF-BIT
- Bituminous collar included
- Four Mio anchors required
- Weight: 11 lbs. (5,0 kg)

Temporary Lifeline 20 mtr



- Art. nr.: EC-THL-LP120
- Weight: 10.94 lbs. (4,96 kg)



Bodyfix PVC



- Art. nr.: EC-BF-PVC
- PVC collar included
- Four Mio anchors required
- Weight: 7.83 lbs. (3,55 kg)

Bodyfix EPDM



- Art. nr.: EC-BF-EPDM
- EPDM collar included
- Four Mio anchors required
- Weight: 7.50 lbs. (3,40 kg)

Mio Concrete Anchors 300 mm



- Art. nr.: EC-MA-10
- Weight: 0.46 lbs. (0,21 kg)

Mio Toggle Bolts 300 mm



- Art. nr.: EC-TP
- Weight: 1.37 lbs. (0,62 kg)

Positioning Line 5/10/20 mtr



- Art. nrs.: EC-PL-5/-10/-20
- Weight 5mtr: 0.71 lbs. (1,57 kg)
- Weight 10mtr: 0.90 lbs. (1,98 kg)
- Weight 20mtr: 1.28 lbs. (2,78 kg)

Karabiner Anti-Pendulum



- Art. nr.: EC-KB

Full Body Harness Professional



- Art. nr.: EC-FBH-PRO
- Weight: 4.21 lbs. (1,91 kg)

Suitcase Storage PPE



- Art. nr.: EC-K
- Dimensions: 48x36x18 cm
- Weight: 4.21 lbs. (1,91 kg)

TWINFIX
EN-795:2012 TYPE A



Twinfix Safety Anchor



- EC-TWL-SA-NT
- Excluding 8 tiles 50x50x5 cm
- Weight: 518 lbs. (235 kg)

Self Retracting Lifeline



- Art. nr.: EC-VSBH-2K
- Length: 2 mtr

Temporary Lifeline 20 mtr



- Art. nr.: EC-THL-LP120
- Weight: 10.94 lbs. (4,96 kg)

Self Retracting Lifeline 6 mtr



- Art. nr.: EC-VSB-6W
- Length: 6 mtr/Webbing

Positioning Line 5/10/20 mtr



- Art. nrs.: EC-PL-5/-10/-20
- Weight 5mtr: 0.71 lbs. (1,57 kg)
- Weight 10mtr: 0.90 lbs. (1,98 kg)
- Weight 20mtr: 1.28 lbs. (2,78 kg)

Full Body Harness Professional



- Art. nr.: EC-FBH-PRO
- Weight: 4.21 lbs. (1,91 kg)

Suitcase Storage PPE



- Art. nr.: EC-K
- Dimensions: 48x36x18 cm
- Weight: 4.21 lbs. (1,91 kg)

RESTRICTFIX
EN-795:2012 TYPE A



Restrictfix bitumen



- Art. nr.: EC-RTF-BIT
- Weight: 10.7 lbs. (4,86 kg)

Restrictfix PVC



- Art. nr.: EC-RTF-PVC
- Weight: 5.9 lbs. (2,68 kg)

Restrictfix EPDM



- Art. nr.: EC-RTF-EPDM
- Weight: 5.9 lbs. (2,68 kg)

Temporary Lifeline 20 mtr



- Art. nr.: EC-THL-LP120
- Weight: 10.94 lbs. (4,96 kg)

Positioning Line 5/10/20 mtr



- Art. nrs.: EC-PL-5/-10/-20
- Weight 5mtr: 0.71 lbs. (1,57 kg)
- Weight 10mtr: 0.90 lbs. (1,98 kg)
- Weight 20mtr: 1.28 lbs. (2,78 kg)

Karabiner Anti-Pendulum



- Art. nr.: EC-KB

Full Body Harness Professional



- Art. nr.: EC-FBH-PRO
- Weight: 4.21 lbs. (1,91 kg)

Suitcase Storage PPE



- Art. nr.: EC-K
- Dimensions: 48x36x18 cm
- Weight: 4.21 lbs. (1,91 kg)

LOOPFIX
EN-795:2012 TYPE A



Loopfix Flat or Bended



- Art. nr.: EC-LFE-F / EC-LFE-B
- Screws included
- Weight: 1.54 lbs. (0,70 kg)

Loopfix Vertical Beam



- Art. nr.: EC-LFE-V
- Bolts included
- Weight: 1.65 lbs. (0,75 kg)

Loopfix Double Beam



- Art. nr.: EC-LFE-DB700
- Screws included
- Range 450 - 700 mm
- Weight: 7.91 lbs. (3,59 kg)

Loopfix Double Beam



- Art. nr.: EC-LFE-DB1200
- Screws included
- Range 930 - 1200 mm
- Weight: 12.3 lbs. (5,59 kg)

Positioning Line 5/10/20 mtr



- Art. nrs.: EC-PL-5/-10/-20
- Weight 5mtr: 0.71 lbs. (1,57 kg)
- Weight 10mtr: 0.90 lbs. (1,98 kg)
- Weight 20mtr: 1.28 lbs. (2,78 kg)

Double Leg Safety Lanyard



- Art. nr.: EC-VLD-4
- Length: 2 mtr
- Weight: 0.72 lbs. (1,58 kg)

Full Body Harness Professional



- Art. nr.: EC-FBH-PRO
- Weight: 4.21 lbs. (1,91 kg)

Suitcase Storage PPE



- Art. nr.: EC-K
- Dimensions: 48x36x18 cm
- Weight: 4.21 lbs. (1,91 kg)

SEAMFIX
EN-795:2012 TYPE A



Seamfix 450



- Art. nr.: EC-SMF-450
- No blocks included
- Four blocks needed
- Weight: 11.77 lbs. (5,34 kg)

Seamfix 660



- Art. nr.: EC-SMF-660
- No blocks included
- Four blocks needed
- Weight: 14.44 lbs. (6,55 kg)

S-5! E-Clamp

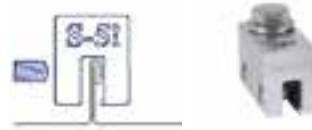

- Art. nr.: EC-SMF-EC

S-5! S-Clamp



- Art. nr.: EC-SMF-SC

S-5! Z-Clamp



- Art. nr.: EC-SMF-ZC

S-5! K-Clamp



- Art. nr.: EC-SMF-KG

Positioning Line 5/10/20 mtr



- Art. nrs.: EC-PL-5/-10/-20
- Weight 5mtr: 0.71 lbs. (1,57 kg)
- Weight 10mtr: 0.90 lbs. (1,98 kg)
- Weight 20mtr: 1.28 lbs. (2,78 kg)

Full Body Harness Professional



- Art. nr.: EC-FBH-PRO
- Weight: 4.21 lbs. (1,91 kg)

Suitcase Storage PPE



- Art. nr.: EC-K
- Dimensions: 48x36x18 cm
- Weight: 4.21 lbs. (1,91 kg)

S-5! R465-Clamp

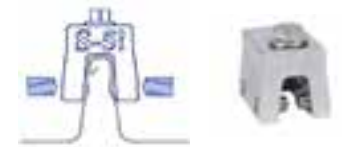

- Art. nr.: EC-SMF-R465

S-5! B-Clamp

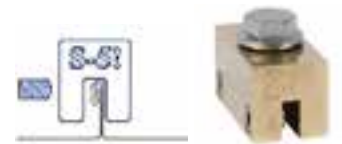

- Art. nr.: EC-SMF-B

SP-ANCHOR
EN-795:2012 TYPE A



Double Safety Lanyard Stretch



- Art. nr.: EC-VLD-4

SP-Anchor



- Art. nr.: EC-SMF-PA
- Two blocks not included
- Weight: 5.16 lbs. (2,34 kg)

S-5! E-Clamp



- Art. nr.: EC-SMF-EC

S-5! S-Clamp



- Art. nr.: EC-SMF-SC

S-5! Z-Clamp



- Art. nr.: EC-SMF-ZC

S-5! K-Clamp



- Art. nr.: EC-SMF-KG

Positioning Line 5/10/20 mtr



- Art. nrs.: EC-PL-5/-10/-20
- Weight 5mtr: 0.71 lbs. (1,57 kg)
- Weight 10mtr: 0.90 lbs. (1,98 kg)
- Weight 20mtr: 1.28 lbs. (2,78 kg)

Full Body Harness Professional



- Art. nr.: EC-FBH-PRO
- Weight: 4.21 lbs. (1,91 kg)

Suitcase Storage PPE



- Art. nr.: EC-K
- Dimensions: 48x36x18 cm
- Weight: 4.21 lbs. (1,91 kg)

S-5! R465-Clamp



- Art. nr.: EC-SMF-R465

S-5! B-Clamp



- Art. nr.: EC-SMF-B

STEELFIX
EN-795:2012 TYPE A



Steelfix EVO



- Art. nr.: EC-SFE
- Bituminous tape included
- 16 Bulb Tite rivets included
- Weight: 4.74 lbs. (2,15 kg)

Steelfix



- Art. nr.: EC-SF
- Bituminous tape included
- 16 Bulb Tite rivets included
- Weight: 4.74 lbs. (2,15 kg)

Steelfix Asia



- Art. nr.: EC-SF-ASIA
- Bituminous tape included
- 16 Bulb Tite rivets included
- Weight: 4.74 lbs. (2,15 kg)

Temporary Lifeline 20 mtr



- Art. nr.: EC-THL-20
- Weight: 10.94 lbs. (4,96 kg)

Positioning Line 5/10/20 mtr



- Art. nrs.: EC-PL-5/-10/-20
- Weight 5mtr: 0.71 lbs. (1,57 kg)
- Weight 10mtr: 0.90 lbs. (1,98 kg)
- Weight 20mtr: 1.28 lbs. (2,78 kg)

Bulb-Tite Rivet Tool



- Art. nr.: EC-TFL-BTR

Full Body Harness Professional



- Art. nr.: EC-FBH-PRO
- Weight: 4.21 lbs. (1,91 kg)

Suitcase Storage PPE



- Art. nr.: EC-K
- Dimensions: 48x36x18 cm
- Weight: 4.21 lbs. (1,91 kg)

SPINFIX
EN-795:2012 TYPE A



Spinfix Filler Plates



- Art. nr.: EC-SFE-RVS
- Bituminous tape included
- 6 Bulb Tite rivets included
- Weight: 0.63 lbs. (0,29 kg)

Spinfix



- Art. nr.: EC-SPF
- Range 90 - 200 mm
- 6 Bulb Tite rivets included
- Weight: 1.60 lbs. (0,73 kg)

Spinfix Large Filler Plates



- Art. nr.: EC-SF
- Bituminous tape included
- 6 Bulb Tite rivets included
- Weight: 0.44 lbs. (0,97 kg)

Spinfix Large



- Art. nr.: EC-SPF-L
- Range 90 - 340 mm
- 6 Bulb Tite rivets included
- Weight: 0.602 lbs. (1,33 kg)

Unitfix Bended



- Art nr.: EC-EYE-UFB
- Bituminous tape included
- 8 Bulb tite rivets included
- Weight: 1.15 lbs. (0,52 kg)

Unitfix Flat



- Art nr.: EC-EYE-UFF
- Bituminous tape included
- 8 Bulb tite rivets included
- Weight: 1.15 lbs. (0,52 kg)

UNITFIX
EN-795:2012 TYPE A

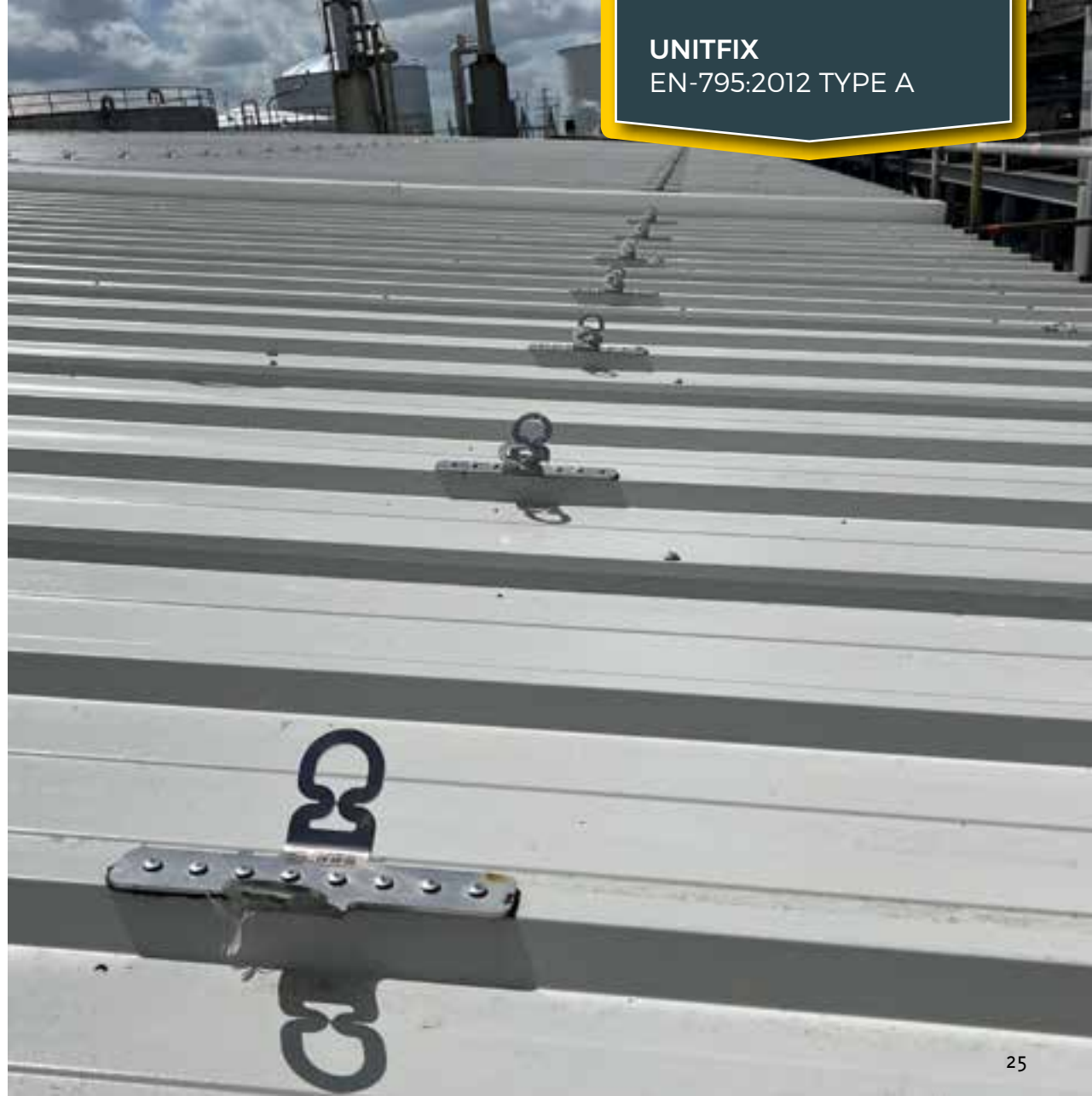

WALLFIX
EN-795:2012 TYPE A

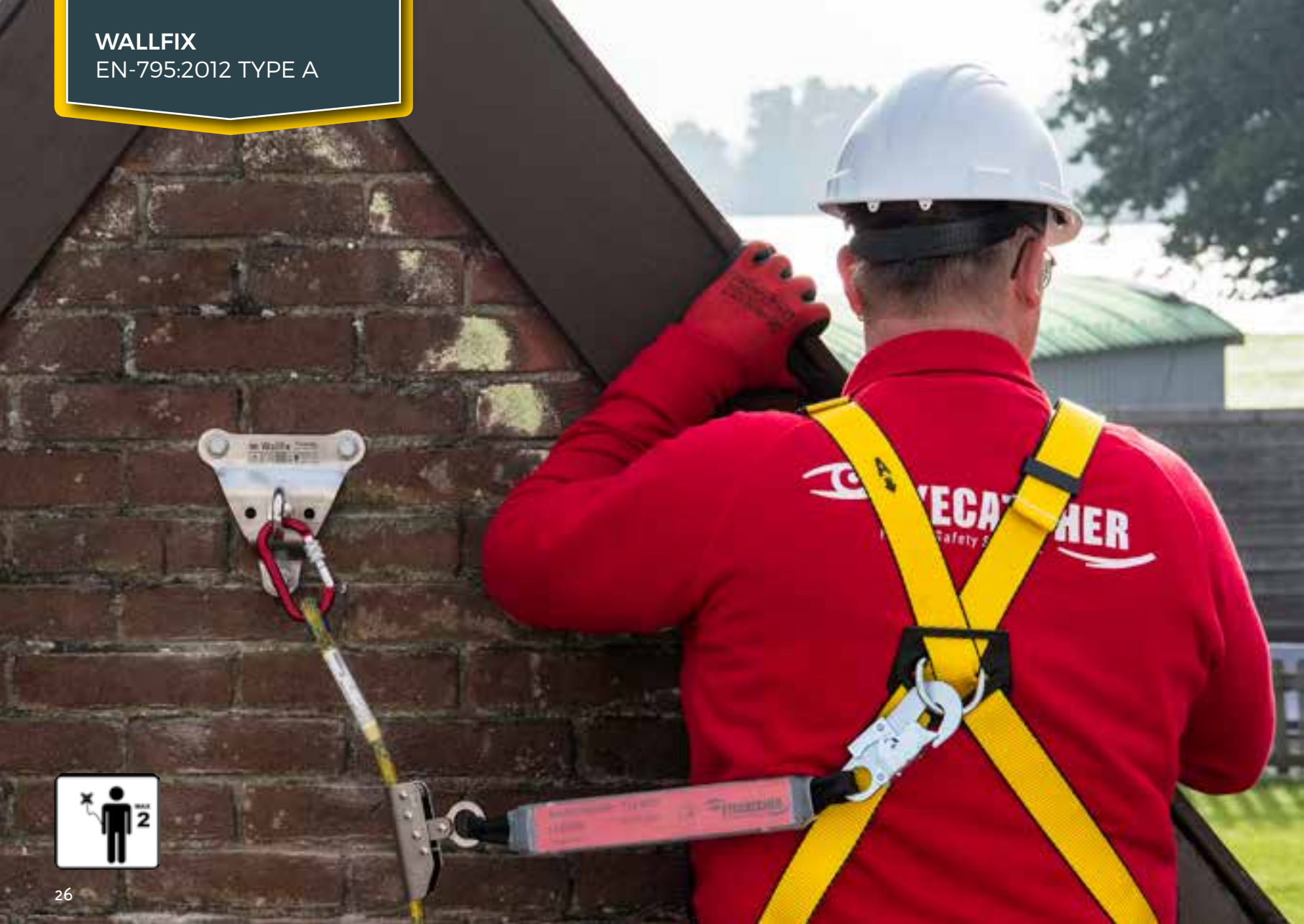

Wallfix Anchor Point



- Art. nr.: EC-WF-AP
- Three Mio anchors required
- Weight: 1.73 lbs. (0,784 kg)

Wallfix KN-AO



- Art. nr.: EC-WF-KNAO
- Three Mio anchors required
- Weight: 2.15 lbs. (0,974 kg)

Mio Concrete anchor



- Art. nr.: EC-CA-10
- Weight: 0.226 lbs. (0,10 kg)

Temporary Lifeline 20 mtr



- Art. nr.: EC-THL-20
- Weight: 10.94 lbs. (4,96 kg)

Self Retracting Lifeline



- Art. nr.: EC-VSBH-2K
- Length: 2 mtr

Positioning Line 5/10/20 mtr



- Art. nrs.: EC-PL-5/-10/-20
- Weight 5mtr: 0.71 lbs. (1,57 kg)
- Weight 10mtr: 0.90 lbs. (1,98 kg)
- Weight 20mtr: 1.28 lbs. (2,78 kg)

Full Body Harness Professional



- Art. nr.: EC-FBH-PRO
- Weight: 4.21 lbs. (1,91 kg)

Suitcase Storage PPE



- Art. nr.: EC-K
- Dimensions: 48x36x18 cm
- Weight: 4.21 lbs. (1,91 kg)

SINGLE SAFETY ANCHORS
EN-795:2012 TYPE A



Single Safety Anchor Eye KN-AO



- Art. nr.: EC-KN-AO
- One M12 anchor required
- Weight: 0.49 lbs. (0,22 kg)

Single Safety Anchor Eye EYE-AP



- Art. nr.: EC-EYE-AP
- One M10 anchor required
- Weight: 0.14 lbs. (0,06kg)

Single Safety Anchor Eye AT185



- Art. nr.: EC-EYEAT185
- One M10 bolt required
- Weight: 1.08 lbs. (0,48 kg)

Single Safety Anchor Eye Mickey



- Art. nr.: EC-EYE-MM
- One M12 or two M10 bolts required
- Weight: 0.84 lbs. (0,38 kg)

Single Safety Anchor Eye DA



- Art. nr.: EC-EYE-DA
- One M12 or M16 bolt required
- Weight: 0.66 lbs. (0,30 kg)

Single Safety Anchor Falcon



- Art. nr.: EC-EYE-F
- Two M10 bolts required
- Weight: 0.77 lbs. (0,35 kg)

Single Safety Anchor EYE-DS



- Art. nr.: EC-EYE-DS
- One M12 bolt required
- Weight: 0.26 lbs. (0,12 kg)

Single Safety Anchor D-Tect



- Art. nr.: EC-EYE-DT
- One M12 bolt required
- Weight: 0.33 lbs. (0,15 kg)

SINGLE SAFETY ANCHORS
EN-795:2012 TYPE A



Single Safety Anchor D-bolt



- Art. nr.: EC-EYE-DB
- One M12 bolt required
- Weight: 1.32 lbs. (0,60 kg)

Vertifix End Bracket



- Art. nr.: EC-VF-EBT
- Weight: 2.93 lbs. (1,33 kg)

EyeFix M12 Bolt



- Art. nr.: EC-EYE-M12B
- Weight: 0.35 lbs. (0,16 kg)

EyeFix M12 Nut



- Art. nr.: EC-EYE-M12N
- Weight: 0.35 lbs. (0,16 kg)

Single Safety Anchor Snapfix



- Art. nr.: EC-EYE-SNF
- One M12 bolt required
- Weight: 0.35 lbs. (0,16 kg)

Concrete Anchor



- Art. nr.: EC-EYE-AT152
- Weight: 0.93 lbs. (0,42 kg)

EyeFix M16 Bolt



- Art. nr.: EC-EYE-M16B
- Weight: 0.60 lbs. (0,27 kg)

EyeFix M16 Nut



- Art. nr.: EC-EYE-M16N
- Weight: 0.60 lbs. (0,27 kg)

DAVIT SYSTEM
FREE STANDING
EN-795:2012 TYPE B&E



DAVIT SYSTEM FIXED
TRIPOD
EN-795:2012 TYPE B



DAVIT SYSTEM
COLUMN CLAMPED
EN-795:2012 TYPE B

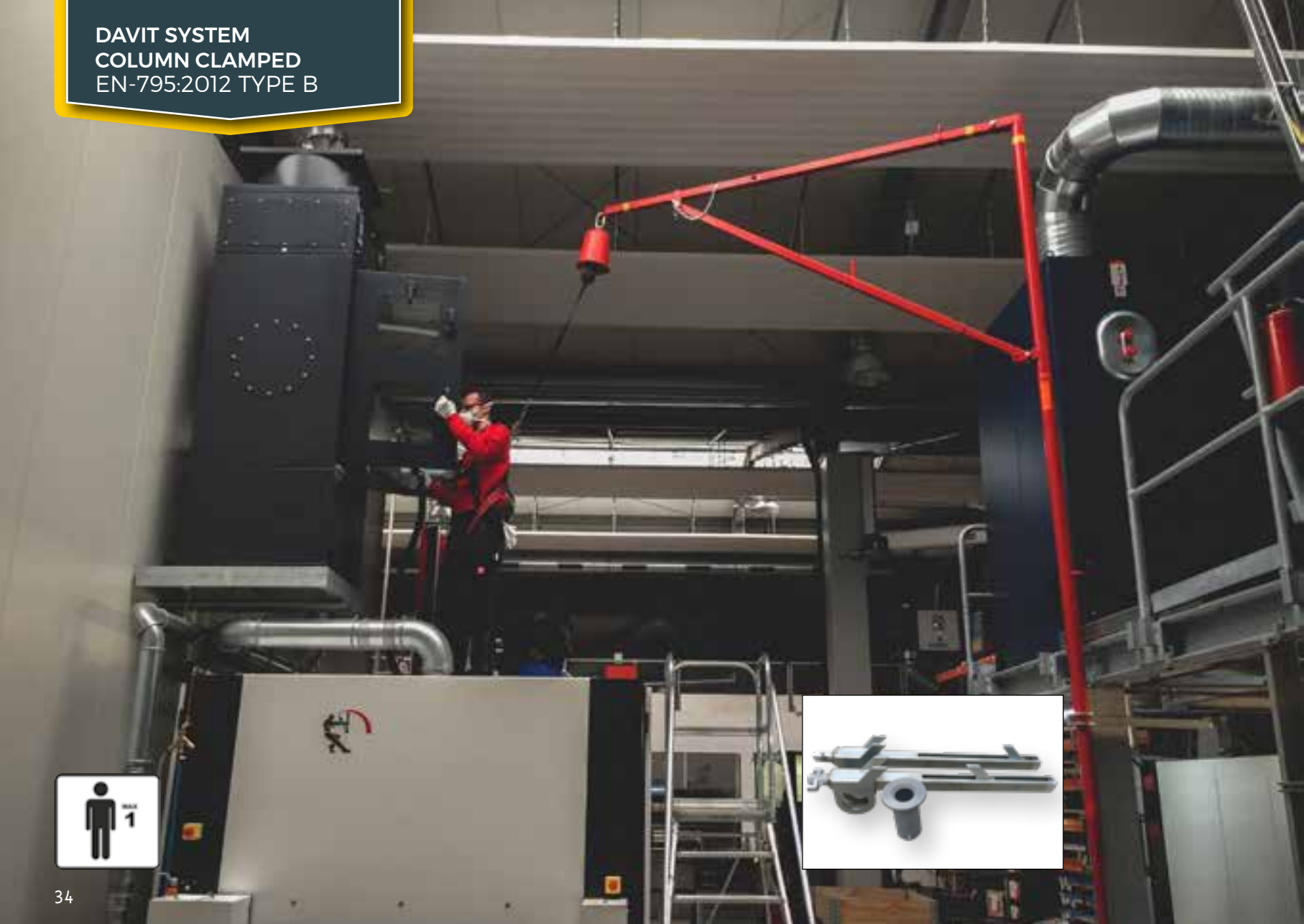

DAVIT SYSTEM CONCRETE
EN-795:2012 TYPE B



DAVIT SYSTEM
DEAD WEIGHT
EN-795:2012 TYPE B&E



**DAVIT SYSTEM
RESTRICTED SPACE
EN-795:2012 TYPE B**



X1250 MOBILE GRABBER
EN-795:2012 TYPE B





X1250 Mobile Grabber Reach Chart

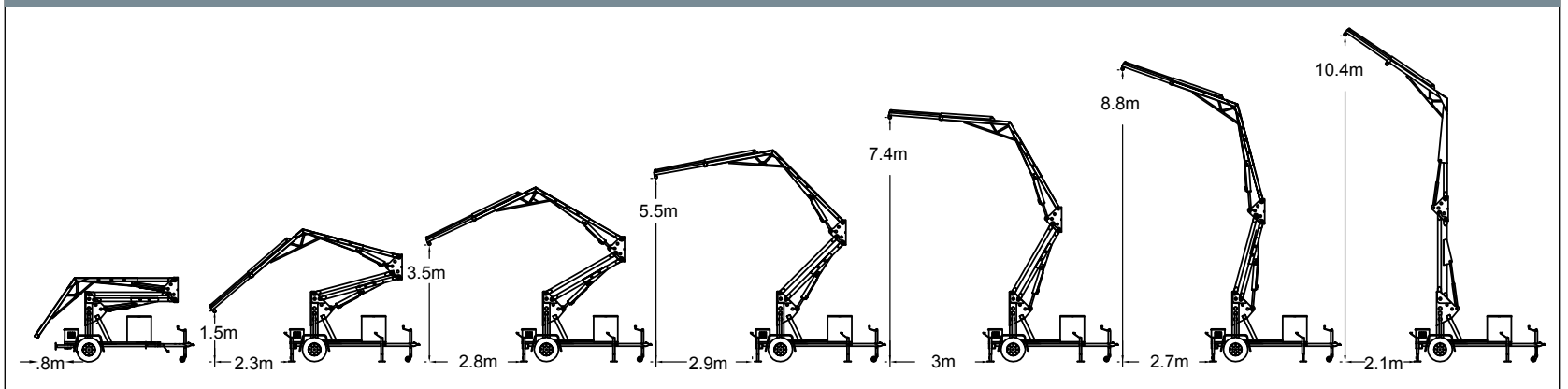

RAIL CLAMPS
EN-795:2012 TYPE B



MP Clamp XL



- Art. nr.: EC-MPC-IBT
- For I- and H-beams
- Weight: 4.85 lbs. (2,2 kg)

Beam Clamp with rollers



- Art. nr.: EC-MPC-R
- For I- and H-beams
- Weight: 7.72 lbs. (3,5 kg)

Beam Clamp vert. and horiz.



- Art. nr.: EC-MPC-V
- For I- and H-beams
- Weight: 5.51 lbs. (2,5 kg)

Positioning Line 5 mtr



- Art. nr.: EC-PL-5
- Weight 5mtr: 0.71 lbs. (1,57 kg)

Lanyard with shock absorber



- Art. nr.: EC-VLD-6
- Weight: 1.40 lbs. (0,63 kg)

Self Retracting Lifeline



- Art. nr.: EV-VSB-6W
- Length: 6 mtr

Full Body Harness Professional



- Art. nr.: EC-FBH-PRO
- Weight: 4.21 lbs. (1,91 kg)

Suitcase Storage PPE



- Art. nr.: EC-K
- Dimensions: 48x36x18 cm
- Weight: 4.21 lbs. (1,91 kg)

**HOLLOW CONCRETE
CLAMP**
EN-795:2012 TYPE B



Hollow Concrete Clamp



- Art. nr.: EC-HCC
- Three persons
- Weight: 17.64 lbs. (8 kg)



Lanyard with shock absorber



- Art. nr.: EC-VLD-6
- Weight: 1.40 lbs. (0,63 kg)

Self Retracting Lifeline



- Art. nr.: EV-VSB-6W
- Length: 6 mtr

Full Body Harness Professional



- Art. nr.: EC-FBH-PRO
- Weight: 4.21 lbs. (1,91 kg)

Suitcase Storage PPE



- Art. nr.: EC-K
- Dimensions: 48x36x18 cm
- Weight: 4.21 lbs. (1,91 kg)

DOORFIX
EN-795:2012 TYPE B



Doorfix Stainless Steel



- Art. nr.: EC-DF
- Certified fall protection 2-persons
- Weight: 21.2 lbs. (9,6 kg)



Doorfix Aluminium



- Art. nr.: EC-DF-ATo65
- Certified fall protection 3-persons
- Weight: 12.1 lbs. (5,5 kg)

Self Retracting Lifeline



- Art. nr.: EV-VSB-6W
- Length: 6 mtr

Positioning Line 5/10/20 mtr



- Art. nrs.: EC-PL-5/-10/-20
- Weight 5mtr: 0.71 lbs. (1,57 kg)
- Weight 10mtr: 0.90 lbs. (1,98 kg)
- Weight 20mtr: 1.28 lbs. (2,78 kg)

Full Body Harness Professional



- Art. nr.: EC-FBH-PRO
- Weight: 4.21 lbs. (1,91 kg)

Suitcase Storage PPE



- Art. nr.: EC-K
- Dimensions: 48x36x18 cm
- Weight: 4.21 lbs. (1,91 kg)

CLICKFIX
EN-795:2012 TYPE B



Clickfix Concrete



- Art. nr.: EC-CF-CRS
- Weight: 0.49 lbs. (0,22 kg)

Lanyard with shock absorber



- Art. nr.: EC-VLD-6
- Weight: 1.40 lbs. (0,63 kg)

Clickfix Steel



- Art. nr.: EC-CF-S
- Weight: 0.71 lbs. (0,32 kg)

Clickfix Universal



- Art. nr.: EC-CF-SC
- Weight: 0.88 lbs. (0,40 kg)

Clickfix Anchor



- Art. nr.: EC-CF-A
- Weight: 0,56 lbs. (0,25 kg)

Positioning Line 5/10/20 mtr



- Art. nrs.: EC-PL-5/-10/-20
- Weight 5mtr: 0.71 lbs. (1,57 kg)
- Weight 10mtr: 0.90 lbs. (1,98 kg)
- Weight 20mtr: 1.28 lbs. (2,78 kg)

Togglefix



- Art. nr.: EC-TFA-43/-63/-83/-103
- Length: 43/63/83/103 mm

Full Body Harness Professional



- Art. nr.: EC-FBH-PRO
- Weight: 4.21 lbs. (1,91 kg)

Suitcase Storage PPE



- Art. nr.: EC-K
- Dimensions: 48x36x18 cm
- Weight: 4.21 lbs. (1,91 kg)

**MOBILE STEEL &
CONCRETE ANCHOR**
EN-795:2012 TYPE B



Rebar Steel Anchor



- Art. nr.: EC-CF-ATi87
- Three persons
- Rebar size 18-32 mm
- Weight: 4.01 lbs. (1,82 kg)

Mobile Concrete Anchor



- Art. nr.: EC-CF-ATo2iT
- One person
- Hole size 20 mm
- Weight: 0.64 lbs. (0,29 kg)

Togglefix



- Art. nr.: EC-TFA-43/-63/-83/-103
- Length: 43/63/83/103 mm

Petzl Coeur Pulse



- Art. nr.: EC-PCP-12
- Hole : 12mm
- Weight: 0.37 lbs. (0,17 kg)

Reusable Hinged Roof Anchor



- Art. nr.: EC-RF-403
- Weigth: 3.3 lbs. (1,5 kg)

Metal Sling



- Art. nr.: EC-SLING-150S
- Length : 1,5 m
- Weight: 1.46 lbs. (0,66 kg)

Suitcase Storage PPE



- Art. nr.: EC-K
- Dimensions: 48x36x18 cm
- Weight: 4.21 lbs. (1,91 kg)

CONTAINER LIFELINE KIT
EN-795:2012 TYPE B



Container post High



- Art. nr.: EC-CLL-P
- Height : 61 cm
- Weight: 21 lbs. (9,5 kg)
- Users: 3 persons



Container post Low



- Art. nr.: EC-CAP
- Height : 23 cm
- Weight: 5,1 lbs. (2,3 kg)
- Users: 1 person

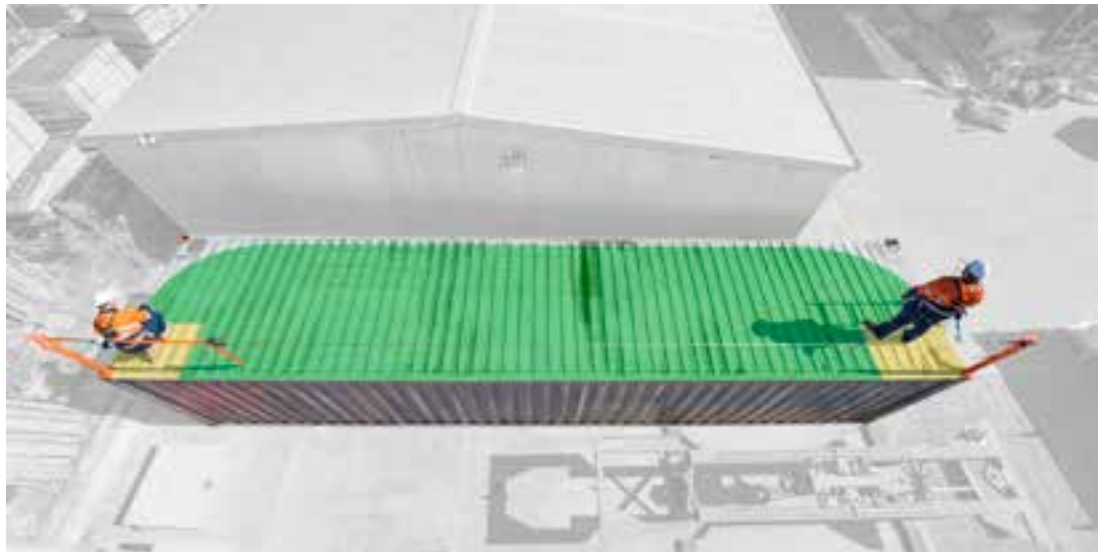

**SAFETY ANCHOR &
SAFETY NETS CONNECTOR**
EN-795:2012 TYPE B



Safety Anchor 3m



- Art. nr.: EC-SA-SNC
- Weight: 4.21 lbs. (1,91 kg)
- Users: 3 persons

Safety Anchor 10m



- Art. nr.: EC-SA-AE100-10
- Weight: 7.45 lbs. (3,38 kg)
- Users: 3 persons

Safety Anchor 20m



- Art. nr.: EC-SA-AE100-20
- Weight: 10.4 lbs. (4,72 kg)
- Users: 3 persons

Positioning Line 5 mtr



- Art. nr.: EC-PL-5
- Weight 5mtr: 0.71 lbs. (1,57 kg)

Lanyard with shock absorber



- Art. nr.: EC-VLD-6
- Weight: 1.40 lbs. (0,63 kg)

Self Retracting Lifeline 3,5 mtr



- Art. nr.: EC-VSBV-3.5GW
- Length: 3,5 mtr/Wire

Self Retracting Lifeline 6 mtr



- Art. nr.: EC-VSB-6W
- Length: 6 mtr/Webbing

Suitcase Storage PPE



- Art. nr.: EC-K
- Dimensions: 48x36x18 cm
- Weight: 4.21 lbs. (1,91 kg)

FIX LIFE LINE SYSTEM
EN-795:2012 TYPE C



Fix End Bracket



- Art. nr.: FixEnd
- Weight: 2.09 lbs. (0,95 kg)

S-type Energy Absorber



- Art. nr.: EC-VF-EA
- Weight: 1.12 lbs. (0,51 kg)

Fix Intermediate Bracket



- Art. nr.: FixIntermediate
- Weight: 2.09 lbs. (0,95 kg)

Fix Corner Bracket



- Art. nr.: FixCorner
- Weight: 2.09 lbs. (0,95 kg)

Fix Bendable Bracket



- Art. nr.: FixCornerBendable
- Weight: 2.09 lbs. (0,95 kg)

Fix Double End Bracket



- Art. nr.: FixEndDouble
- Weight: 2.09 lbs. (0,95 kg)

Swageless Tensioner & Crimp Fitting



- Art. nrs.: EC-TFL-TSW / EC-VF-CFSW
- Weight: 0.68/1.7 lbs. (0,31/0,78 kg)

Tensioner & Crimp Fitting



- Art. nrs.: EC-TFL-T / EC-VF-CF
- Weight: 1.19/0.31 lbs. (0,54/0,14 kg)

Shuttle / Shuttle Fixed



- Art. nr.: EC-ST-G / EC-ST-GF
- Weight: 0.71 lbs. (0,32 kg)

Fix Extender



- Art. nr.: FixExtender
- Weight : 0.95 lbs (0,43 kg)

TWISTFIX
EN-795:2012 TYPE C



Twistfix End



- Art. nr.: EC-TFL-EP
- Four Mio anchors required
- Weight: 8.05 lbs. (3,65 kg)

S-type Energy Absorber



- Art. nr.: EC-VF-EA
- Weight: 1.12 lbs. (0,51 kg)

Swageless Tensioner & Crimp Fitting



- Art. nrs.: EC-TFL-TSW / EC-VF-CFSW
- Weight: 0.68/1.7 lbs. (0,31/0,78 kg)

Tensioner & Crimp Fitting



- Art. nrs.: EC-TFL-T / EC-VF-CF
- Weight: 1.19/0.31 lbs. (0,54/0,14 kg)

Shuttle / Shuttle Fixed



- Art. nr.: EC-ST-G / EC-ST-GF
- Weight: 0.71 lbs. (0,32 kg)

Twistfix Intermediate



- Art. nr.: EC-TFL-TP
- One M12 anchor required
- Weight: 3.04 lbs. (1,38 kg)

Twistfix 90 degrees



- Art. nr.: EC-TFL-HP
- Four M10 anchors required
- Weight: 8.80 lbs. (3,99 kg)

Twistfix Bendable



- Art. nr.: EC-TFL-HPB
- Four M10 anchors required
- Weight: 8.05 lbs. (3,65 kg)

Twistfix Double End



- Art. nr.: EC-TFL-EPD
- Four M10 anchors required
- Weight: 8.22 lbs. (3,73 kg)

Steel Wire Cable AISI 316



- Art. nr.: EC-LS-SK
- 8 mm 7x19 ID-ribbon
- Weight: 0,26 kg/mtr

Positioning Line 5/10/20 mtr



- Art. nrs.: EC-PL-5/-10/-20
- Weight 5mtr: 0.71 lbs. (1,57 kg)
- Weight 10mtr: 0.90 lbs. (1,98 kg)
- Weight 20mtr: 1.28 lbs. (2,78 kg)

Full Body Harness Professional



- Art. nr.: EC-FBH-PRO
- Weight: 4.21 lbs. (1,91 kg)

Twistfix Extender



- Art. nr.: EC-TFL-XT
- Four M10 anchors required
- Weight: 8.22 lbs. (3,73 kg)

STEEL POLE LINE SYSTEM EN-795:2012 TYPE C



Steel Pole End



- Art. nr.: EC-SP-EP
- Height: 300/400/500 mm

S-type Energy Absorber



- Art. nr.: EC-VF-EA
- Weight: 1.12 lbs. (0,51 kg)

Crimp Fitting



- Art. nr.: EC-VF-CF
- Weight: 0.31 lbs. (0,14 kg)

Tensioner



- Art. nr.: EC-TFL-T
- Weight: 1.19 lbs. (0,54 kg)

Shuttle / Shuttle Fixed



- Art. nr.: EC-ST-G / EC-ST-GF
- Weight: 0.71 lbs. (0,32 kg)

Steel Pole Intermediate



- Art. nr.: EC-SP-TP
- Height: 300/400/500 mm

Steel Pole Corner



- Art. nr.: EC-SP-HP
- Height: 300/400/500 mm

Steel Pole Bendable



- Art. nr.: EC-SP-HPB
- Height: 300/400/500 mm

Steel Pole Double End



- Art. nr.: EC-SP-EPD
- Height: 300/400/500 mm

PVC Waterproof set



- Art. nr.: EC-SP-WPVC

Bitume Waterproof set



- Art. nr.: EC-SP-WBIT

EPDM Waterproof set

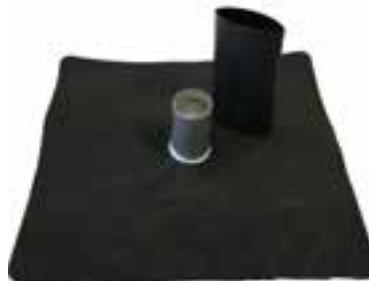

- Art. nr.: EC-SP-WEPDM

Steel Pole Extender



- Art. nr.: EC-SP-XT
- Height: 300/400/500 mm

TWISTFIX EVO
EN-795:2012 TYPE C



Twistfix EVO End



- Art. nr.: EC-TFL-EPE
- Four M10 anchors required
- Weight: 3.70 lbs. (1,68 kg)

S-type Energy Absorber



- Art. nr.: EC-VF-EA
- Weight: 1.12 lbs. (0,51 kg)

Swageless Tensioner & Crimp Fitting



- Art. nrs.: EC-TFL-TSW / EC-VF-CFSW
- Weight: 0.68/1.7 lbs. (0,31/0,78 kg)

Tensioner & Crimp Fitting



- Art. nrs.: EC-TFL-T / EC-VF-CF
- Weight: 1.19/0.31 lbs. (0,54/0,14 kg)

Shuttle / Shuttle Fixed



- Art. nr.: EC-ST-G / EC-ST-GF
- Weight: 0.71 lbs. (0,32 kg)

Twistfix EVO Intermediate



- Art. nr.: EC-TFL-TPE
- One M12 anchor required
- Weight: 1.55 lbs. (0,70 kg)

Twistfix EVO 90 degrees



- Art. nr.: EC-TFL-HPE
- Four M10 anchors required
- Weight: 4.50 lbs. (2,04 kg)

Twistfix EVO Bendable



- Art. nr.: EC-TFL-HPEB
- Four M10 anchors required
- Weight: 3.62 lbs. (1,64 kg)

Twistfix EVO Double End



- Art. nr.: EC-TFL-EPED
- Four M10 anchors required
- Weight: 3.90 lbs. (1,77 kg)

Steel Wire Cable AISI 316



- Art. nr.: EC-LS-SK
- 8 mm 7x19 ID-ribbon
- Weight: 0,26 kg/mtr

Positioning Line 5/10/20 mtr



- Art. nrs.: EC-PL-5/-10/-20
- Weight 5mtr: 0.71 lbs. (1,57 kg)
- Weight 10mtr: 0.90 lbs. (1,98 kg)
- Weight 20mtr: 1.28 lbs. (2,78 kg)

Full Body Harness Professional



- Art. nr.: EC-FBH-PRO
- Weight: 4.21 lbs. (1,91 kg)

Twistfix EVO Extender



- Art. nr.: EC-TFL-EXT
- Four M10 anchors required
- Weight: 3.90 lbs. (1,77 kg)

SOLARFIX LOW
EN-795:2012 TYPE C



Solarfix End



- Art. nr.: EC-SFXL-EP
- One M12 anchor required
- Weight: 3.70 lbs. (1,68 kg)

Shuttle / Shuttle Fixed



- Art. nr.: EC-ST-G / EC-ST-GF
- Weight: 0.71 lbs. (0,32 kg)



Solarfix Intermediate



- Art. nr.: EC-SFXL-TP
- One M12 anchor required
- Weight: 3.40 lbs. (1,54 kg)

Solarfix 90 degrees



- Art. nr.: EC-SFXL-HP
- One M12 anchor required
- Weight: 4.28 lbs. (1,94 kg)

Solarfix Bendable



- Art. nr.: EC-SFXL-HPB
- One M12 anchor required
- Weight: 3.50 lbs. (1,59 kg)

Solarfix Double End



- Art. nr.: EC-SFXL-EPB
- One M12 anchor required
- Weight: 3.57 lbs. (1,62 kg)

Steel Wire Cable AISI 316



- Art. nr.: EC-LS-SK
- 8 mm 7x19 ID-ribbon
- Weight: 0,26 kg/mtr

S-type Energy Absorber



- Art. nr.: EC-VF-EA
- Weight: 1.12 lbs. (0,51 kg)

Tensioner & Crimp Fitting



- Art. nrs.: EC-TFL-T / EC-VF-CF
- Weight: 1.19/0.31 lbs.
(0,54/0,14 kg)

Solarfix Extender



- Art. nr.: EC-SFXL-XT
- One M12 anchor required
- Weight: 3.48 lbs. (1,58 kg)

BODYFIX
EN-795:2012 TYPE C



Bodyfix End



- Art. nr.: EC-BFL-EP
- Four Mio anchors required
- Weight: 11.2 lbs. (5,10 kg)

S-type Energy Absorber



Swageless Tensioner & Crimp Fitting



Tensioner & Crimp Fitting



Shuttle / Shuttle Fixed



Bodyfix Intermediate



- Art. nr.: EC-BFL-TP
- Four Mio anchors required
- Weight: 10.9 lbs. (4,96 kg)

Bodyfix 90 degrees



- Art. nr.: EC-BFL-HP
- Four Mio anchors required
- Weight: 12.0 lbs. (5,46 kg)

Bodyfix Bendable

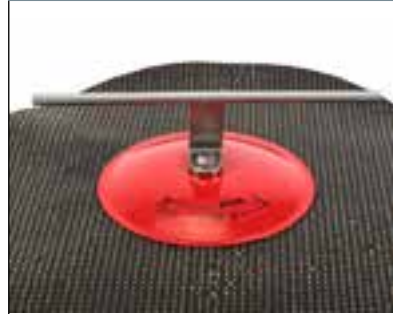

- Art. nr.: EC-BFL-HPB
- Four Mio anchors required
- Weight: 11.2 lbs. (5,07 kg)

Bodyfix Double End



- Art. nr.: EC-BFL-EPD
- Four Mio anchors required
- Weight: 11.5 lbs. (5,20 kg)

Steel Wire Cable AISI 316



- Art. nr.: EC-LS-SK
- 8 mm 7x19 ID-ribbon
- Weight: 0,26 kg/mtr

Positioning Line 5/10/20 mtr



- Art. nrs.: EC-PL-5/-10/-20
- Weight 5mtr: 0.71 lbs. (1,57 kg)
- Weight 10mtr: 0.90 lbs. (1,98 kg)
- Weight 20mtr: 1.28 lbs. (2,78 kg)

Full Body Harness Professional



- Art. nr.: EC-FBH-PRO
- Weight: 4.21 lbs. (1,91 kg)

Bodyfix Extender



- Art. nr.: EC-BFL-XT
- Four Mio anchors required
- Weight: 11.5 lbs. (5,20 kg)

TWINFIX
EN-795:2012 TYPE C



Twinfix End



- Art. nr.: EC-TWL-EP-NT
- Excluding 8 tiles 50x50x5 cm
- Weight: 518 lbs. (235 kg)

S-type Energy Absorber



- Art. nr.: EC-VF-EA
- Weight: 1.12 lbs. (0,51 kg)

Swageless Tensioner & Crimp Fitting



- Art. nrs.: EC-TFL-TSW / EC-VF-CFSW
- Weight: 0.68/1.7 lbs. (0,31/0,78 kg)

Tensioner & Crimp Fitting



- Art. nrs.: EC-TFL-T / EC-VF-CF
- Weight: 1.19/0.31 lbs. (0,54/0,14 kg)

Shuttle / Shuttle Fixed



- Art. nr.: EC-ST-G / EC-ST-GF
- Weight: 0.71 lbs. (0,32 kg)

Twinfix Intermediate



- Art. nr.: EC-TWL-IB-NT
- Excluding 8 tiles 50x50x5 cm
- Weight: 518 lbs. (235 kg)

Twinfix 90 degrees



- Art. nr.: EC-TWL-CB-NT
- Excluding 8 tiles 50x50x5 cm
- Weight: 518 lbs. (235 kg)

Twinfix Bendable



- Art. nr.: EC-TWL-CBB-NT
- Excluding 8 tiles 50x50x5 cm
- Weight: 518 lbs. (235 kg)

Twinfix Double End



- Art. nr.: EC-TWL-EPD-NT
- Excluding 8 tiles 50x50x5 cm
- Weight: 518 lbs. (235 kg)

Steel Wire Cable AISI 316



- Art. nr.: EC-LS-SK
- 8 mm 7x19 ID-ribbon
- Weight: 0,26 kg/mtr

Positioning Line 5/10/20 mtr



- Art. nrs.: EC-PL-5/-10/-20
- Weight 5mtr: 0.71 lbs. (1,57 kg)
- Weight 10mtr: 0.90 lbs. (1,98 kg)
- Weight 20mtr: 1.28 lbs. (2,78 kg)

Full Body Harness Professional



- Art. nr.: EC-FBH-PRO
- Weight: 4.21 lbs. (1,91 kg)

Twinfix Extender



- Art. nr.: EC-TWL-XT-NT
- Excluding 8 tiles 50x50x5 cm
- Weight: 518 lbs. (235 kg)

SEAMFIX 450
EN-795:2012 TYPE C



Seamfix End



- Art. nr.: EC-SMFL-450-EP
- Range 260 - 450 mm
- Four S-5! Blocks required
- Weight: 1.8 lbs. (4,0 kg)

S-type Energy Absorber



- Art. nr.: EC-VF-EA
- Weight: 1.12 lbs. (0,51 kg)

Swageless Tensioner & Crimp Fitting



- Art. nrs.: EC-TFL-TSW / EC-VF-CFSW
- Weight: 0.68/1.7 lbs. (0,31/0,78 kg)

Tensioner & Crimp Fitting



- Art. nrs.: EC-TFL-T / EC-VF-CF
- Weight: 1.19/0.31 lbs. (0,54/0,14 kg)

Shuttle / Shuttle Fixed



- Art. nr.: EC-ST-G / EC-ST-GF
- Weight: 0.71 lbs. (0,32 kg)

Seamfix Intermediate



- Art. nr.: EC-SMFL-450-IB
- Range 260 - 450 mm
- Four S-5! Blocks required
- Weight: 1.7 lbs. (3,8 kg)

Seamfix 90 degrees



- Art. nr.: EC-SMFL-450-CP
- Range 260 - 450 mm
- Four S-5! Blocks required
- Weight: 2.0 lbs. (4,4 kg)

Seamfix Bendable



- Art. nr.: EC-SMFL-450-CPB
- Range 260 - 450 mm
- Four S-5! Blocks required
- Weight: 1.8 lbs. (4,0 kg)

Seamfix Double End



- Art. nr.: EC-SMFL-450-EPD
- Range 260 - 450 mm
- Four S-5! Blocks required
- Weight: 1.8 lbs. (4,1 kg)

Steel Wire Cable AISI 316



- Art. nr.: EC-LS-SK
- 8 mm 7x19 ID-ribbon
- Weight: 0,26 kg/mtr

Positioning Line 5/10/20 mtr



- Art. nrs.: EC-PL-5/-10/-20
- Weight 5mtr: 0.71 lbs. (1,57 kg)
- Weight 10mtr: 0.90 lbs. (1,98 kg)
- Weight 20mtr: 1.28 lbs. (2,78 kg)

Full Body Harness Professional



- Art. nr.: EC-FBH-PRO
- Weight: 4.21 lbs. (1,91 kg)

Seamfix Extender



- Art. nr.: EC-SMFL-450-XT
- Range 260-450mm
- Four S-5! Blocks required
- Weight: 1.8 lbs. (4,1 kg)

SEAMFIX 660
EN-795:2012 TYPE C



Seamfix End



- Art. nr.: EC-SMFL-660-EP
- Range 420 - 660 mm
- Four S-5! Blocks required
- Weight: 11.7 lbs. (6,2 kg)

S-type Energy Absorber



- Art. nr.: EC-VF-EA
- Weight: 1.12 lbs. (0,51 kg)

Swageless Tensioner & Crimp Fitting



- Art. nrs.: EC-TFL-TSW / EC-VF-CFSW
- Weight: 0.68/1.7 lbs. (0,31/0,78 kg)

Tensioner & Crimp Fitting



- Art. nrs.: EC-TFL-T / EC-VF-CF
- Weight: 1.19/0.31 lbs. (0,54/0,14 kg)

Shuttle / Shuttle Fixed



- Art. nr.: EC-ST-G / EC-ST-GF
- Weight: 0.71 lbs. (0,32 kg)

Seamfix Intermediate



- Art. nr.: EC-SMFL-660-IB
- Range 420 - 660 mm
- Four S-5! Blocks required
- Weight: 13.4 lbs. (6,1 kg)

Seamfix 90 degrees



- Art. nr.: EC-SMFL-660-CP
- Range 420 - 660 mm
- Four S-5! Blocks required
- Weight: 14.5 lbs. (6,6 kg)

Seamfix Bendable



- Art. nr.: EC-SMFL-660-CPB
- Range 420 - 660 mm
- Four S-5! Blocks required
- Weight: 13.7 lbs. (6,2 kg)

Seamfix Double End



- Art. nr.: EC-SMFL-660-EPD
- Range 420 - 660 mm
- Four S-5! Blocks required
- Weight: 13.9 lbs. (6,3 kg)

Steel Wire Cable AISI 316



- Art. nr.: EC-LS-SK
- 8 mm 7x19 ID-ribbon
- Weight: 0,26 kg/mtr

Positioning Line 5/10/20 mtr



- Art. nrs.: EC-PL-5/-10/-20
- Weight 5mtr: 0.71 lbs. (1,57 kg)
- Weight 10mtr: 0.90 lbs. (1,98 kg)
- Weight 20mtr: 1.28 lbs. (2,78 kg)

Full Body Harness Professional



- Art. nr.: EC-FBH-PRO
- Weight: 4.21 lbs. (1,91 kg)

Seamfix Extender



- Art. nr.: EC-SMFL-660-XT
- Range 420-660mm
- Four S-5! Blocks required
- Weight: 13.9 lbs. (6,3 kg)

STEELFIX
EN-795:2012 TYPE C



Steelfix End



- Art. nr.: EC-SFL-EP
- Bituminous tape included
- 16 Bulb Tite rivets included
- Weight: 5.16 lbs. (2,34 kg)

S-type Energy Absorber



- Art. nr.: EC-VF-EA
- Weight: 1.12 lbs. (0,51 kg)

Swageless Tensioner & Crimp Fitting



- Art. nrs.: EC-TFL-TSW / EC-VF-CFSW
- Weight: 0.68/1.7 lbs. (0,31/0,78 kg)

Tensioner & Crimp Fitting



- Art. nrs.: EC-TFL-T / EC-VF-CF
- Weight: 1.19/0.31 lbs. (0,54/0,14 kg)

Shuttle / Shuttle Fixed



- Art. nr.: EC-ST-G / EC-ST-GF
- Weight: 0.71 lbs. (0,32 kg)

Steelfix Intermediate



- Art. nr.: EC-SFL-TP
- Bituminous tape included
- 16 Bulb Tite rivets included
- Weight: 4.85 lbs. (2,20 kg)

Steelfix 90 degrees



- Art. nr.: EC-SFL-HP
- Bituminous tape included
- 16 Bulb Tite rivets included
- Weight: 5.93 lbs. (2,69 kg)

Steelfix Bendable



- Art. nr.: EC-SFL-HPB
- Bituminous tape included
- 16 Bulb Tite rivets included
- Weight: 5.11 lbs. (2,32 kg)

Steelfix Double End



- Art. nr.: EC-SFL-EPD
- Bituminous tape included
- 16 Bulb Tite rivets included
- Weight: 5.38 lbs. (2,44 kg)

Steel Wire Cable AISI 316



- Art. nr.: EC-LS-SK
- 8 mm 7x19 ID-ribbon
- Weight: 0,26 kg/mtr

Positioning Line 5/10/20 mtr



- Art. nrs. : EC-PL-5/-10/-20
- Weight 5mtr: 0.71 lbs. (1,57 kg)
- Weight 10mtr: 0.90 lbs. (1,98 kg)
- Weight 20mtr: 1.28 lbs. (2,78 kg)

Full Body Harness Professional



- Art. nr.: EC-FBH-PRO
- Weight: 4.21 lbs. (1,91 kg)

Steelfix Extender



- Art. nr.: EC-SFL-XT
- Bituminous tape included
- 16 Bulb Tite Rivets included
- Weight: 5.38 lbs. (2,44 kg)



S-type Energy Absorber



- Art. nr.: EC-VF-EA
- Weight: 1.12 lbs. (0,51 kg)

Steelfix Asia End



- Art. nr.: EC-SFLA-EP
- Bituminous tape included
- 16 Bulb Tite rivets included
- Weight: 5.16 lbs. (2,34 kg)

Tensioner & Crimp Fitting



- Art. nrs.: EC-TFL-T / EC-VF-CF
- Weight: 1.19/0.31 lbs.
(0,54/0,14 kg)

Shuttle / Shuttle Fixed



- Art. nr.: EC-ST-G / EC-ST-GF
- Weight: 0.71 lbs. (0,32 kg)

Steelfix Asia Intermediate



- Art. nr.: EC-SFLA-TP
- Bituminous tape included
- 16 Bulb Tite rivets included
- Weight: 4.85 lbs. (2,20 kg)

Steelfix Asia 90 degrees



- Art. nr.: EC-SFLA-HP
- Bituminous tape included
- 16 Bulb Tite rivets included
- Weight: 5.93 lbs. (2,69 kg)

Steelfix Asia Bendable



- Art. nr.: EC-SFLA-HPB
- Bituminous tape included
- 16 Bulb Tite rivets included
- Weight: 5.11 lbs. (2,32 kg)

Steelfix Asia Double End



- Art. nr.: EC-SFLA-EPD
- Bituminous tape included
- 16 Bulb Tite rivets included
- Weight: 5.38 lbs. (2,44 kg)

Steel Wire Cable AISI 316



- Art. nr.: EC-LS-SK
- 8 mm 7x19 ID-ribbon
- Weight: 0,26 kg/mtr

Positioning Line 5/10/20 mtr



- Art. nrs.: EC-PL-5/-10/-20
- Weight 5mtr: 0.71 lbs. (1,57 kg)
- Weight 10mtr: 0.90 lbs. (1,98 kg)
- Weight 20mtr: 1.28 lbs. (2,78 kg)

Steelfix Asia C-Bracket



- Art. nr.: EC-SFLA-CB
- Weight: 0.44 lbs. (0,20 kg)

Steelfix Asia Extender



- Art. nr.: EC-SFLA-XT
- Bituminous tape included
- 16 Bulb Tite Rivets included
- Weight: 5.38 lbs. (2,44 kg)

SPINFIX
EN-795:2012 TYPE C



Spinfix End



- Art. nr.: EC-SPFL-EB
- Bituminous tape included
- 6 Bulb Tite rivets included
- Weight: 3.44 lbs. (1,56 kg)

S-type Energy Absorber



- Art. nr.: EC-VF-EA
- Weight: 1.12 lbs. (0,51 kg)

Swageless Tensioner & Crimp Fitting



- Art. nrs.: EC-TFL-TSW / EC-VF-CFSW
- Weight: 0.68/1.7 lbs. (0,31/0,78 kg)

Tensioner & Crimp Fitting



- Art. nrs.: EC-TFL-T / EC-VF-CF
- Weight: 1.19/0.31 lbs. (0,54/0,14 kg)

Shuttle / Shuttle Fixed



- Art. nr.: EC-ST-G / EC-ST-GF
- Weight: 0.71 lbs. (0,32 kg)

Spinfix Intermediate



- Art. nr.: EC-SPFL-IP
- Bituminous tape included
- 6 Bulb Tite rivets included
- Weight: 3.13 lbs. (1,42 kg)

Spinfix 90 degrees



- Art. nr.: EC-SPFL-CB
- Bituminous tape included
- 6 Bulb Tite rivets included
- Weight: 4.23 lbs. (1,92 kg)

Spinfix Bendable



- Art. nr.: EC-SPFL-CBB
- Bituminous tape included
- 6 Bulb Tite rivets included
- Weight: 3.37 lbs. (1,53 kg)

Spinfix Double End



- Art. nr.: EC-SPFL-EBD
- Bituminous tape included
- 6 Bulb Tite rivets included
- Weight: 3.65 lbs. (1,66 kg)

Steel Wire Cable AISI 316



- Art. nr.: EC-LS-SK
- 8 mm 7x19 ID-ribbon
- Weight: 0,26 kg/mtr

Positioning Line 5/10/20 mtr



- Art. nrs.: EC-PL-5/-10/-20
- Weight 5mtr: 0.71 lbs. (1,57 kg)
- Weight 10mtr: 0.90 lbs. (1,98 kg)
- Weight 20mtr: 1.28 lbs. (2,78 kg)

Full Body Harness Professional



- Art. nr.: EC-FBH-PRO
- Weight: 4.21 lbs. (1,91 kg)

Spinfix Extender



- Art. nr.: EC-SPFL-XT
- Bituminous tape included
- 6 Bulb Tite Rivets included
- Weight: 3.65 lbs. (1,66 kg)

WALLFIX FLAT
EN-795:2012 TYPE C



Wallfix Flat End



- Art. nr.: EC-WFF-EP
- Three M10 anchors required
- Weight: 2.50 lbs. (1,14 kg)

S-type Energy Absorber



- Art. nr.: EC-VF-EA
- Weight: 1.12 lbs. (0,51 kg)

Swageless Tensioner & Crimp Fitting



- Art. nrs.: EC-TFL-TSW / EC-VF-CFSW
- Weight: 0.68/1.7 lbs. (0,31/0,78 kg)

Tensioner & Crimp Fitting



- Art. nrs.: EC-TFL-T / EC-VF-CF
- Weight: 1.19/0.31 lbs. (0,54/0,14 kg)

Shuttle / Shuttle Fixed



- Art. nr.: EC-ST-G / EC-ST-GF
- Weight: 0.71 lbs. (0,32 kg)

Wallfix Flat Intermediate



- Art. nr.: EC-WFF-IP
- Three Mio anchors required
- Weight: 2.20 lbs. (1,0 kg)

Wallfix Flat Inside Corner



- Art. nr.: EC-WFF-CBI
- Six Mio anchors required
- Weight: 4.63 lbs. (2,1 kg)

Wallfix Flat Outside Corner



- Art. nr.: EC-WFF-CBO
- Six Mio anchors required
- Weight: 4.63 lbs. (2,1 kg)

Wallfix Flat Bendable Corner



- Art. nr.: EC-WFF-CBB
- Three Mio anchors required
- Weight: 2.43 lbs. (1,1 kg)

Steel Wire Cable AISI 316



- Art. nr.: EC-LS-SK
- 8 mm 7x19 ID-ribbon
- Weight: 0,26 kg/mtr

Lanyard with shock absorber



- Art. nr.: EC-VLD-6
- Weight: 1.40 lbs. (0,63 kg)

Full Body Harness Professional



- Art. nr.: EC-FBH-PRO
- Weight: 4.21 lbs. (1,91 kg)

Suitcase Storage PPE



- Art. nr.: EC-K
- Dimensions: 48x36x18 cm
- Weight: 4.21 lbs. (1,91 kg)

WALLFIX SUPPORT
EN-795:2012 TYPE C



Wallfix Support End



- Art. nr.: EC-WFS-EP
- Three M10 anchors required
- Weight: 2.89 lbs. (1,31 kg)

S-type Energy Absorber



- Art. nr.: EC-VF-EA
- Weight: 1.12 lbs. (0,51 kg)

Swageless Tensioner & Crimp Fitting



- Art. nrs.: EC-TFL-TSW / EC-VF-CFSW
- Weight: 0.68/1.7 lbs. (0,31/0,78 kg)

Tensioner & Crimp Fitting



- Art. nrs.: EC-TFL-T / EC-VF-CF
- Weight: 1.19/0.31 lbs. (0,54/0,14 kg)

Shuttle / Shuttle Fixed



- Art. nr.: EC-ST-G / EC-ST-GF
- Weight: 0.71 lbs. (0,32 kg)

Wallfix Support Intermediate



- Art. nr.: EC-WFS-IP
- Three Mio anchors required
- Weight: 2.58 lbs. (1,17 kg)

Wallfix Support Inside Corner



- Art. nr.: EC-WFS-CBI
- Six Mio anchors required
- Weight: 4.63 lbs. (2,1 kg)

Wallfix Support Outside Corner



- Art. nr.: EC-WFS-CBO
- Six Mio anchors required
- Weight: 4.63 lbs. (2,1 kg)

Wallfix Support Bendable Corner



- Art. nr.: EC-WFS-CBB
- Three Mio anchors required
- Weight: 2.80 lbs. (1,27 kg)

Steel Wire Cable AISI 316



- Art. nr.: EC-LS-SK
- 8 mm 7x19 ID-ribbon
- Weight: 0,26 kg/mtr

Lanyard with shock absorber



- Art. nr.: EC-VLD-6
- Weight: 1.40 lbs. (0,63 kg)

Full Body Harness Professional



- Art. nr.: EC-FBH-PRO
- Weight: 4.21 lbs. (1,91 kg)

Suitcase Storage PPE



- Art. nr.: EC-K
- Dimensions: 48x36x18 cm
- Weight: 4.21 lbs. (1,91 kg)

TRAVELFIX
EN-795:2012 TYPE C



Travelfix Trolley With Rollers



- Art. nr.: EC-TRF-TR
- Weight: 1.01 lbs. (0,46 kg)

Travelfix Intermediate Bracket



- Art. nr.: EC-TRF-IB
- Weight: 1.53 lbs. (0,70 kg)

Travelfix End Bracket



- Art. nr.: EC-TRF-EB
- Weight: 2.09 lbs. (0,95 kg)

Swageless Tensioner & Crimp Fitting



- Art. nrs.: EC-TFL-TSW / EC-VF-CFSW
- Weight: 0.68/1.7 lbs. (0,31/0,78 kg)

S-type Energy Absorber



- Art. nr.: EC-VF-EA
- Weight: 1.12 lbs. (0,51 kg)

Travelfix Beam Clamp small/large



- Art. nr.: EC-TRF-BCS/-BCL
- Weight: 2.00 lbs. (0,91 kg)/ 2.56 lbs. (1,16 kg)

Tensioner & Crimp Fitting



- Art. nrs.: EC-TFL-T / EC-VF-CF
- Weight: 1.19/0.31 lbs. (0,54/0,14 kg)

Steel Wire Cable AISI 316



- Art. nr.: EC-LS-SK
- 8 mm 7x19 ID-ribbon
- Weight: 0,26 kg/mtr

SAFERAIL
EN-795:2012 TYPE D



SAFERAIL
EN-353-1:2014



SAFERAIL
EN-353-1:2014







FABA Grip Slider



- Art. nr.: EC-FABA-GS
- Weight:

FABA Rail



- Art. nr.: EC-FABA-R
- Weight:

FABA Mast Connector



- Art. nr.: EC-FABA-MC
- Weight:

FABA Wall Bracket



- Art. nr.: EC-FABA-WB
- Weight:

FABA Rail Connector



- Art. nr.: EC-FABA-RC
- Weight:

FABA End Stop



- Art. nr.: EC-FABA-E
- Weight:

FABA Rail Entrance



- Art. nr.: EC-FABA-RE
- Weight:

Full Body Harness Professional



- Art. nr.: EC-FBH-MA15

CROSSFIX
EN-795:2012 TYPE E



Crossfix



- Art. nr.: EC-CRF-1
- 1-person
- Weight: 584 lbs. (265 kg)

Crossfix



- Art. nr.: EC-CRF-2
- 2-persons
- Weight: 760 lbs. (345 kg)

Deadweight Angel Anchor



- Art. nr.: EC-DW-A2
- 2-persons
- Weight: 1322 lbs. (600 kg)

Self Retracting Lifeline 3,5 mtr



- Art. nr.: EC-VSBH-3.5GW
- Length: 3,5 mtr/Wire

Self Retracting Lifeline 6 mtr



- Art. nr.: EC-VSB-6W
- Length: 6 mtr/Webbing

Positioning Line 5/10/20 mtr



- Art. nrs.: EC-PL-5/-10/-20
- Weight 5mtr: 0.71 lbs. (1,57 kg)
- Weight 10mtr: 0.90 lbs. (1,98 kg)
- Weight 20mtr: 1.28 lbs. (2,78 kg)

Full Body Harness Professional



- Art. nr.: EC-FBH-PRO
- Weight: 4.21 lbs. (1,91 kg)

Suitcase Storage PPE



- Art. nr.: EC-K
- Dimensions: 48x36x18 cm
- Weight: 4.21 lbs. (1,91 kg)

BIGFOOT
EN-795:2012 TYPE E





BigFoot



- Art. nr.: EC-BF-DWA
- Weight: 750 lbs. (340 kg)
- Users: 2 persons
- Size: 1 x 1,2 m



Positioning Line 5/10/20 mtr



- Art. nrs.: EC-PL-5/-10/-20
- Weight 5mtr: 0.71 lbs. (1,57 kg)
- Weight 10mtr: 0.90 lbs. (1,98 kg)
- Weight 20mtr: 1.28 lbs. (2,78 kg)



Vertifix End Bracket



- Art. nr.: EC-VF-EBT
- Weight: 2.93 lbs. (1,33 kg)

S-type Energy Absorber



- Art. nr.: EC-VF-EA
- Weight: 1.12 lbs. (0,51 kg)

Vertifix Rope Grab



ATEX Certified



- Art. nr.: EC-VF-RG
- Karabiner included
- Weight: 1.49 lbs. (0,674 kg)

Vertifix Elongation Bar



- Art. nr.: EC-VF-E
- U-Brackets included
- Maximum 1,5 meters
- Weight: 9.16 lbs. (4,16 kg)

Vertifix Intermediate Bracket



- Art. nr.: EC-VF-IBR
- Weight: 1.85 lbs. (0.84 kg)

Vertifix Bottom Bracket



- Art. nr.: EC-VF-EBB
- Weight: 2.54 lbs. (1,15 kg)

Swageless Tensioner & Crimp Fitting



- Art. nrs.: EC-TFL-TSW / EC-VF-CFSW
- Weight: 0.68/1.7 lbs. (0,31/0,78 kg)

Tensioner & Crimp Fitting



- Art. nrs.: EC-TFL-T / EC-VF-CF
- Weight: 1.19/0.31 lbs. (0,54/0,14 kg)

Steel Wire Cable AISI 316



- Art. nr.: EC-LS-SK
- 8 mm 7x19 ID-ribbon
- Weight: 0,26 kg/mtr

Vertifix Shuttle



- Art. nr.: EC-VF-S
- Weight: 5,4 lbs. (2,4 kg)

Full Body Harness Professional



- Art. nr.: EC-FBH-PRO
- Weight: 4.21 lbs. (1,91 kg)

Suitcase Storage PPE



- Art. nr.: EC-K
- Dimensions: 48x36x18 cm
- Weight: 4.21 lbs. (1,91 kg)

ROOFFIX
EN-517:2006 TYPE B



Rooffix Flat or Bended



- Art. nr.: EC-RF-F / EC-RF-B
- Screws included
- Weight: 1.86 lbs. (0,844 kg)

Rooffix Vertical Beam



- Art. nr.: EC-RF-V
- Screws included
- Weight: 2.03 lbs. (0,92 kg)

Rooffix Double Beam



- Art. nr.: EC-RF-DB700
- Screws included
- Range 450 - 700 mm
- Weight: 8.38 lbs. (3,8 kg)

Rooffix Double Beam



- Art. nr.: EC-RF-DB1200
- Screws included
- Range 930 - 1200 mm
- Weight: 12.9 lbs. (5,86 kg)

Positioning Line 5/10/20 mtr



- Art. nrs.: EC-PL-5/-10/-20
- Weight 5mtr: 0.71 lbs. (1,57 kg)
- Weight 10mtr: 0.90 lbs. (1,98 kg)
- Weight 20mtr: 1.28 lbs. (2,78 kg)

Lanyard with shock absorber



- Art. nr.: EC-VLD-6
- Weight: 1.40 lbs. (0,63 kg)

Full Body Harness Professional



- Art. nr.: EC-FBH-PRO
- Weight: 4.21 lbs. (1,91 kg)

Suitcase Storage PPE



- Art. nr.: EC-K
- Dimensions: 48x36x18 cm
- Weight: 4.21 lbs. (1,91 kg)

LADDERBRACKET



Ladder Bracket Low



- Art. nr.: EC-LOPB-LD
- Weight: 2.09 lbs. (0,95 kg)

Ladder Bracket Eyecatcher



- Art. nr.: EC-LOPB-EYE
- Weight: 4.14 lbs. (1,88 kg)

Ladder Bracket Flexible



- Art. nr.: EC-LOPB-F
- Weight: 2.73 lbs. (1,24 kg)

Ladder Bracket Adjustable



- Art. nr.: EC-LOPB-AJ
- Weight: 1,98 lbs. (0,9 kg)

Ladder Mat



- Art. nr.: EC-LM
- Weight: 18.7 lbs. (8,5 kg)

Ladder Strap



- Art. nr.: EC-LOPB-BR
- Weight: 0.42 lbs. (0,19 kg)

Roof Entrance



- Art. nr.: EC-P-VB
- Weight: 0.31 lbs. (0,14 kg)

Ladder Clamps Carroof



- Art. nr.: EC-LAD-CC
- Weight: 6.17 lbs. (2,8 kg)

SAFETY SIGNS



No Entry



- Art. nr.: EC-P-VT
- Weight: 0.24 lbs. (0,11 kg)

Roof Entrance



- Art. nr.: EC-P-VB
- Weight: 0.31 lbs. (0,14 kg)

PPE Required



- Art. nr.: EC-P-VBC
- Weight: 0.24 lbs. (0,11 kg)

Risk of Falling



- Art. nr.: EC-P-VG
- Weight: 0.24 lbs. (0,11 kg)

Risk of Tripping



- Art. nr.: EC-P-SG
- Weight: 0.24 lbs. (0,11 kg)

Danger of Falling Through



- Art. nr.: EC-P-DVG
- Weight: 0.24 lbs. (0,11 kg)

Danger



- Art. nr.: EC-P-D
- Weight: 0.24 lbs. (0,11 kg)

Non-Ionizing Radiation



- Art. nr.: EC-P-NIR
- Weight: 0.24 lbs. (0,11 kg)

ROOF ACCESS & CAGE LADDERS



Hatch Ladder Hand Assist



■ Art. nr.: EC-RHP

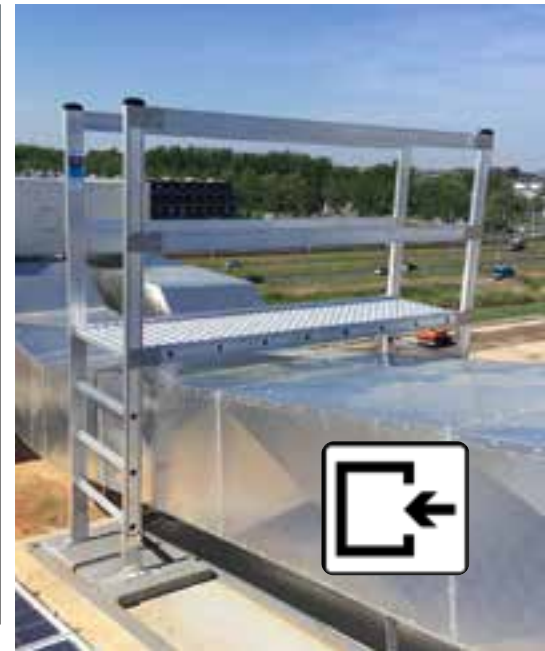

GUARDRAIL & ROOF LIGHTS



FULL BODY HARNESSSES
EN-361/EN-358/EN-813



Full Body Harness Basic I



■ Art. nr.: EC-FBH-MA60

Full Body Harness Veleta



■ Art. nr.: EC-FBH-V

Full Body Harness Basic 2



■ Art. nr.: EC-FBH-MA70

Full Body Harness Basic 3



■ Art. nr.: EC-FBH-MA10A

Full Body Harness Professional



■ Art. nr.: EC-FBH-MA15

Full Body Harness Expert



■ Art. nr.: EC-FBH-MA19

Full Body Harness ATEX



■ Art. nr.: EC-FBH-2iCAT

Hook Release Triangle



■ Art. nr.: EC-HRT
■ Weight: 2.09 lbs. (0,95 kg)

Trauma Suspension Straps



■ Art. nr.: EC-SRS

Green Safety Tag



■ Art. nr.: EC-GST-L
■ Length: 300mm

SAFETY LANYARD
EN-354/EN-355/EN-353-2



Safety Lanyard Adjustable



■ Art. nr.: EC-PLZI-180K

Safety Lanyard Adjustable



■ Art. nr.: EC-PLZI-180S

Safety Lanyard 1,5m



■ Art. nr.: EC-PLZ-E91

Safety Lanyard 1,5m



■ Art. nr.: EC-PLZ-E95

Safety Lanyard Stretch



■ Art. nr.: EC-VLD-2

Double Safety Lanyard Stretch



■ Art. nr.: EC-VLD-4

Safety Lanyard Stretch



■ Art. nr.: EC-VLD-6

Safety Lanyard Rope



■ Art. nr.: EC-VLD-37

Double Safety Lanyard Rope



■ Art. nr.: EC-VLD-35

Safety Lanyard Adjustable Loops



■ Art. nr.: EC-VLD-53BS

Safety Lanyard ATEX



■ Art. nr.: EC-VLD-12AT

Safety Lanyard Dielectric



■ Art. nr.: EC-VLD-14X

Positioning Line 5m



■ Art. nr.: EC-PL-5

Positioning Line 10m



■ Art. nr.: EC-PL-10

Positioning Line 20m



■ Art. nr.: EC-PL-20

Energy Absorber



■ Art. nr.: EC-D402

**SELF RETRACTABLE
LIFELINES**
EN-360



SRL 2m Webbing Vertical



■ Art. nr.: EC-VSB-2

SRL 3,5m Webbing Vertical



■ Art. nr.: EC-VSBV-3,5W

SRL 6m Webbing Vertical



■ Art. nr.: EC-VSB-6W

SRL 10m Wire Vertical



■ Art. nr.: Art. nr.: EC-VSBH-10W

SRL 10m Webbing Vertical



■ Art. nr.: EC-VSBV-10W

SRL 15m Wire Cable Vertical



■ Art. nr.: EC-VSBV-15GW

SRL 6m Webbing Horizontal



■ Art. nr.: EC-VSBH-6W

SRL 10m Webbing Horizontal



■ Art. nr.: EC-VSBH-10W

**KARABINERS &
SCAFFOLD HOOKS**
EN-362/EN-12275



Karabiner Alu Screw-lock



■ Art. nr.: EC-CA2120-SC

Karabiner Alu Twist-Lock



■ Art. nr.: EC-CA2120-TW

Karabiner Alu Tri-Lock



■ Art. nr.: EC-CA2120-TR

Karabiner Steel Captive Pin



■ Art. nr.: EC-KB-M51

Karabiner Steel Screw Lock



■ Art. nr.: EC-CS2440-SC

Karabiner Steel Twist Lock



■ Art. nr.: EC-CS2440-TW

Karabiner Steel Tri Lock



■ Art. nr.: EC-CS2440-TR

Scaffold Hook Alu 62mm



■ Art. nr.: EC-CA238-SH

Scaffold Hook Steel 56mm



■ Art. nr.: EC-SH

Scaffold Hook Alu 110mm



■ Art. nr.: EC-CA350-SH

Hook Release Triangle



■ Art. nr.: EC-HRT

Trauma Suspension Straps



■ Art. nr.: EC-SRS

LOOSE PARTS FIX LINE SYSTEM

Fix End Bracket



- Art. nr.: FixEnd
- Weight: 2.09 lbs. (0,95 kg)

Fix Intermediate Bracket



- Art. nr.: FixIntermediate
- Weight: 2.09 lbs. (0,95 kg)

Fix Corner Bracket



- Art. nr.: FixCorner
- Weight: 2.09 lbs. (0,95 kg)

Fix Bendable Corner



- Art. nr.: FixCornerBendable
- Weight: 2.09 lbs. (0,95 kg)

S-type Energy Absorber



- Art. nr.: EC-VF-EA
- Weight: 1.12 lbs. (0,51 kg)

Swageless Tensioner & Crimp Fitting



- Art. nrs.: EC-TFL-TSW / EC-VF-CFSW
- Weight: 0.68/1.7 lbs. (0,31/0,78 kg)

Tensioner & Crimp Fitting



- Art. nrs.: EC-TFL-T / EC-VF-CF
- Weight: 1.19/0.31 lbs. (0,54/0,14 kg)

Tensioner Seal



- Art. nr.: EC-TFL-TS
- Length: 35 cm

ID Plate



- Art. nr.: EC-ID

Green Safety Tag



- Art. nr.: EC-GST-L
- Length: 30 cm

Green Safety Tag Cutter



- Art. nr.: EC-GST-C
- Weight: 0.13 lbs. (0,06 kg)

Green Safety Tag Plier



- Art. nr.: EC-GST-P
- Weight: 0.24 lbs. (0,11 kg)

M10 Toggle Bolts 300 mm



- Art. nr.: EC-TP
- Weight: 1.37 lbs. (0,62 kg)

M10 Concrete Anchors 300 mm



- Art. nr.: EC-MA-10
- Weight: 0.46 lbs. (0,21 kg)

M12 Concrete Anchor 300 mm



- Art. nr.: EC-MA-12
- Weight: 0.73 lbs. (0,33 kg)

M12 Toggle Bolt 300 mm



- Art. nr.: EC-TF-TP300
- Weight: 1.37 lbs. (0,62 kg)

INSTALLATION TOOLS

Hole Saw 44 mm



■ Art. nr.: EC-GTZ-44

Hole Saw Arbor 44 mm



■ Art. nr.: EC-GTZ-44HC

Hole Saw 30 mm



■ Art. nr.: EC-GTZ-30

Hole Saw Arbor 30 mm



■ Art. nr.: EC-GTZ-30HC

Crimping Tool Complete



■ Art. nr.: EC-TFL-CT

Jaws Holder Complete



■ Art. nr.: EC-TFL-CTA

Jaw 2-segment



■ Art. nr.: EC-TFL-CTB

Bulb-Tite Rivet Tool



■ Art. nr.: EC-TFL-BTR

Toggle Bolt M12 Tool



- Art. nr.: EC-VPS

Wire Cable Cutter



- Art. nr.: EC-TFL-WC
- Cable: 8 mm

Life Line Grabber



- Art. nr.: EC-LL-G

Concrete Tool M10/M12



- Art. nr.: EC-VPS-17/-19
- Length: 50 cm

Life Line Fixator



- Art. nr.: EC-LL-F

Life Line Lightning Cable



- Art. nr.: EC-LL-LC

Cable Repair Kit REMS/Unknown



- Art. nr.: EC-CS/-CSU
- Weight: 0.11 lbs. (0,05 kg) / 0.24 lbs. (0,11 kg)

Life Line Cable Tension Meter



- Art. nr.: EC-LL-CT
- Weight: 1.32 lbs. (0,60 kg)

HEIGHT SAFETY SYSTEMS

1. WIND TURBINE

- Anchor Points
- EN-795:2012 type A & CEN/TS-16415:2013
- KN-AO, EYE-AP, Clickfix Steel

2. CONFINED SPACES

- Rescue and Evacuation
- EN-795:2012 type B & EN-341:2011/A/IB
- Tripods, Descenders and Rescue devices

3. LADDERS / VERTICAL LINE- AND RAIL-SYSTEM

- Vertical line- and railsystem
- EN-353-1:2014
- Vertifix, Saferail

4. PERMANENT ROOF EDGE PROTECTION

- Guardrail
- EN-14122-3 & EN-13374
- Guardrail permanent and free standing

5. LADDERS / VERTICAL LINE- AND RAIL-SYSTEM

- Vertical line- and railsystem
- EN-131 & NEN-2484 & EN-14122-4 & EN-353-1:2014
- Permanent ladders, Cageladders, Vertifix, Saferail

6. TEMPORARY ROOF EDGE PROTECTION

- Guardrail
- EN-14122-3 & EN-13374

7. SMALL ROOFS

- Dead Weight Anchor
- EN-795:2012 type E & CEN/TS-16415:2013
- Crossfix

8. INDUSTRIAL BUILDINGS / MAGAZINES / STORAGE AND TRANSFER STATIONS

- Overhead line- and railsystems
- EN-795:2012 type C & CEN/TS-16415:2013
- Travelfix, Saferail

9. OPENINGS AND DOOR FRAMES

- Mobile Anchor Point
- EN-795:2012 type B & CEN/TS-16415:2013
- Doorfix, Clickfix Concrete, Clickfix Steel

10. OPENINGS AND WINDOWS

- Mobile and Permanent Anchor Point
- EN-795:2012 type A/B & CEN/TS-16415:2013
- EYE-AP, KN-AO, Doorfix, Clickfix concrete

11. ROOF ENTRANCE & SIGNS

- Ladder Brackets, Signs, (Cage-)Ladder

12. WALLS

- Anchor Points and Line Systems
- EN-795:2012 type A/C & CEN/TS-16415:2013
- KN-AO, EYE-AP, Wallfix, Travelfix

13. FLAT ROOF DOMES

- Guardrails
- EN-14122-3 & EN-13374
- Flat Roof Domes Guardrail

14. FLAT ROOFS

- Anchor Points and Line Systems
- EN-795:2012 type A/C & CEN/TS-16415:2013
- Twistfix, Bodyfix

15. REPAIRS AND INSPECTION

- Inspections, Maintenance, Repares, Risk Analysis
- Anchor Points, Line Systems, Roofs, PPE

16. SOLAR ENERGIE

- Support
- Solarfix

17. GREEN ROOFS

- Anchor Points and Line Systems
- EN-795:2012 type A/C & CEN/TS-16415:2013
- Twistfix

18. TEMPORARY LINE SYSTEMS

- Anchor Points and Line Systems
- EN-795:2012 type A & CEN/TS-16415:2013
- Twistfix, Bodyfix, Temporary Lines

19. METAL AND STANDING SEAM ROOFS

- Anchor Points and Line Systems
- EN-795:2012 type A/C & CEN/TS-16415:2013
- Spinflix, Steelfix, Seamfix

20. PERMANENT & MOBILE OVERHEAD

- Overhead Anchor Points and Rail Systems
- EN-795:2012 type B & CEN/TS-16415:2013

21. MOBILE FALL PROTECTION

- EN-795:2012 type B
- X1250 Mobile Grabber

HEIGHT SAFETY SYSTEMS





Eyecatcher BV Candelastraat 2 | 2441 LR Nieuwveen | The Netherlands
T +31(0)172-57 55 70 | E info@eyecatchersafety.com